



Task 38 Solar Air-Conditioning and Refrigeration

Benchmarks for comparison of system simulation tools – Absorption chiller simulation comparison

**A technical report of subtask C
Deliverable C2-B**

Date: Novembre 9, 2009

By Constanze Bongs¹

Contributions by:

Antoine Dalibard², Paul Kohlenbach³, Olivier Marc⁴, Ignasi Gurruchaga⁵, Marco Zetzsche⁶, Panagiotis Tsekouras⁷, Edo Wiemken⁸, Paul Bourdoukan⁹, Franciska Klein¹⁰

¹Fraunhofer Institute for Solar Energy Systems (ISE)

Heidenhofstraße 2, 79110 Freiburg, Germany

Phone: +49 (0)761/ 45 88-54 87

Fax: +49 (0)761/ 45 88-94 87

e-mail: constanze.bongs@ise.fraunhofer.de

²ZAFH.NET (Stuttgart University of Applied Sciences)

Schellingstraße 24, 70174 Stuttgart, Germany

Phone: +49 (0)711/ 89 26-29 81

Fax: +49 (0)711/ 89 26-26 98

e-mail: antoine.dalibard@hft-stuttgart.de

³Solem Consulting

Postfach 2127, 71370 Weinstadt, Germany

Phone: +49 (0)174/ 41 30 92 1

Fax: +49 (0)7151/ 60 48 62 5

e-mail: info@solem-consulting.com

⁴Laboratory of Building Physics and Systems

University of Reunion Island, 40 avenue de Soweto, 97410 Saint Pierre, France

Phone: +262 (0) 692/ 53 56 24

Fax: +262 (0) 262/ 96 28 99

e-mail: olivier.marc@univ-reunion.fr

⁵AIGUASOL Engineering

Roger de Lluria 29, 3, 2, 08009 Barcelona, Spain

Phone: +34 93 342 47 55

Fax: +34 93 342 47 56

e-mail: ignasi.gurruchaga@aiguasol.coop

⁶Universität Stuttgart, Institut für Thermodynamik und Wärmetechnik (ITW)

Pfaffenwaldring 6, 70550 Stuttgart, Germany

Phone: +49 (0)711/ 685-63 23 0

Fax : +49 (0)711/ 685-63 50 3

e-mail: zetzsche@itw.uni-stuttgart.de

⁷CRES - Centre for Renewable Energy Sources

19th km Marathonos Av., Pikermi – 19009, Greece

Phone: +30 210 66 03 300

Fax: +30 210 66 03 301

e-mail: ptsek@cres.gr

⁸Fraunhofer Institute for Solar Energy Systems (ISE)

Heidenhofstraße 2, 79110 Freiburg, Germany

Phone: +49 (0)761/ 45 88-54 12

Fax: +49 (0)761/ 45 88-94 12

e-mail: edo.wiemken@ise.fraunhofer.de

⁹ INES – CNRS – LOCIE

50 avenue du lac Léman, 73375 Le Bourget du Lac, France

e-mail: paul.bourdoukan@gmail.de

¹⁰Solution Solartechnik GmbH

Hauptstraße 27, 4642 Sattledt, Germany

Phone: +43 7244/ 20 28 02 3

Fax: +43 7244/ 20 28 0 - 18

e-mail: franciska.klein@sol-ution.com

Contents

1	Introduction	5
1.1	Selection of simulation tools	5
1.2	General structure of benchmarking.....	7
1.3	Key performance parameters	8
2	Absorption chiller simulation benchmark.....	10
2.1	Office building simulation description.....	10
2.1.1	General Design.....	10
2.1.2	Construction details	11
2.1.3	Internal loads	12
2.2	Cooling and heating loads of building simulation.....	13
2.2.1	Initial building simulation for four different locations	13
2.2.2	Load file description of initial Perpignan simulation – 1 st iteration	15
2.2.3	Load file description of final Palermo simulation – 2 nd iteration	15
2.3	System definition.....	16
2.3.1	System definition of Perpignan simulation – 1 st iteration	16
2.3.2	System definition of Palermo simulation – 2 nd iteration	18
2.4	System control strategy	21
2.4.1	System control of Perpignan simulation – 1 st iteration.....	21
2.4.2	System control of Palermo simulation – 2 nd iteration	21
2.5	Simulation results and comparison	24
2.5.1	Perpignan simulation – comparison of first results	24
2.5.2	Palermo simulation – comparison of main results	26
3	Conclusions.....	37
4	Bibliography	39

1 Introduction

Simulation in solar cooling and air-conditioning is possible at different levels. A classification may be made by sorting the tools into

- materials level: analysing the effect of e.g. different sorption materials on the sorption process. Objective: improvement of process efficiency;
- component level: detailed analysis of a system component, e.g., chillers, cooling towers, etc. Objective: improvement of component control strategies and identification of potential component improvements and adaptations to the solar support system;
- process quality level: theoretical analysis of various processes. Objective: to identify exergy flows, LCA, thermodynamic limits, etc.;
- detailed system simulation for optimising control strategies of pump operation, switching levels, etc.;
- **system simulation for planning support. Objective: to identify an appropriate system size with respect to fulfill target values in primary energy savings, solar thermal system exploitation, economics, etc.**

The latter, highlighted system simulation is subject of this document. The wording 'system' used in this context comprises the arrangement of components, necessary to provide heating, cooling and /or air-conditioning to a defined object (building or industrial application). The structure of the exercise as described in the following was initially elaborated by Edo Wiemken and Paul Bourdoukan.

1.1 Selection of simulation tools

A few simulation programs for planning support and sizing of solar assisted air-conditioning systems exist. The following list does not claim to be complete, some more programs used internally may exist; additionally, more commercial simulation platforms like Matlab/Simulink, Modelica, etc. can be used, but do not provide of a sufficient number of components for modelling a complete solar air-conditioning system yet.

TRNSYS – A commercial time step simulation tool worldwide available. High flexibility in the choice and arrangement of the system components, the desired system can be constructed by selecting and connecting the individual components and by defining the system control. Own written 'types' (component models) may be added. Once the time step of the simulation is chosen, it is constant during the simulation run. A major advantage of the program is the availability of a building model, which can be edited in a special building editor and allows the calculation of building loads. Within IEA Task 25, components for thermally driven chillers have been developed.

INSEL – A commercial simulation tool which allows modelling and simulation of photovoltaic and thermal systems by creating the desired system out of a comprehensive component library. For solar thermal air-conditioning systems, component models like thermally driven chillers are available as well. Likewise TRNSYS, the system is designed using a graphical user interface. Building simulation is not integrated yet.

COLSIM – A non-commercial open source simulation tool, applicable under Linux operating software. COLSIM is modular like TRNSYS, but allows more sophisticated control strategies

in the short time range. Concerning cooling and air-conditioning equipment, few components are available so far and thus, more composition of the types by the user is required.

TRANSOL – A user-friendly simulation tool for solar thermal systems based on TRNSYS models. More than 40 different TRNSYS systems for solar thermal, including Solar Air Conditioning and Industrial processes system, are already constructed in order to allow the user choosing between them. An easy interface facing detailed TRNSYS models which contains worldwide meteorological data from Meteonorm 6, allows generating own heating and cooling demands based on building model, parametrical studies, contains extended materials data base, shadow calculation, inertial solar collector model with bidimensional IAM definition for CPC, new real-approach TRNSYS components, customized reports and online plotters with operational time analysis and energy, environmental and economical balances.

SPARK/ Energy Plus - SPARK is an object-oriented simulation environment which can generally be applied for any physical modelling. It includes an algebraic equation solver and solves a set of equations – unlike in sequential programming the order of equations must not be fixed by the user (similarly to Modelica). Therefore, it may be applied to specify individual models. SPARK may be coupled with Energy Plus. Energy Plus is an energy analysis and thermal load tool. It is mainly designed for building simulation, but especially allows coupling the building model with HVAC systems allowing for the simulation of feedback-systems. Therefore, it also gives the maximum degrees of freedom to the users and allows simulation on a level of detail comparable to TRNSYS, INSEL or COLSIM.

SOLAC – A simulation tool focusing especially on solar assisted air-conditioning systems. This software was developed within Task 25 under co-ordination of ILK Dresden. SOLAC allows on a medium-level the composition of a system out of a HVAC equipment library. Focus is on ventilation systems, but two types of commercially available thermally driven chillers are available as well. SOLAC requires a fixed formatted input data file with meteorological and building load data in hourly time resolution. The internal time resolution in the simulation is some minutes. The program is available free of charge in its present test version.

EasyCool – A fast pre-design tool especially for solar thermal assisted air-conditioning systems. EasyCool provides a set of 11 system configurations, of which the desired configuration may be selected. The program requires a fixed formatted input data file with meteorological and building load data in hourly time resolution. EasyCool offers the possibility to calculate also a conventional non-solar reference system. Beside an annual energy balance, the program returns annual economic data for the solar thermal assisted configuration and for the reference configuration. The program calculates within one simulation run a defined range of system sizes (varying the collector area and the hot water storage volume).

Although the mentioned simulation programs may calculate the whole system, the information content of the output differs strongly with respect to the depth of information and type of information (energetic, economical, or technical orientation of the output). Whereas e.g. TRNSYS allows to program the output in the desired way, in SOLAC and EasyCool the output information is fixed. A benchmark procedure to compare the results of the different programs, has to take this fact into account.

For this reason, the benchmarks focuses on the – from the view of a system pre-design - most relevant topics of comparability of achieved environmental savings and system performance.

Objective of the benchmark testing is not a judgement on the quality of the simulation programs, but to identify the range of uncertainty of the results and to assess weaknesses and strengths of each program.

1.2 General structure of benchmarking

The general approach of the benchmark procedure for the simulation tools is described in the following. A sketch of the general approach is shown in Figure 1.

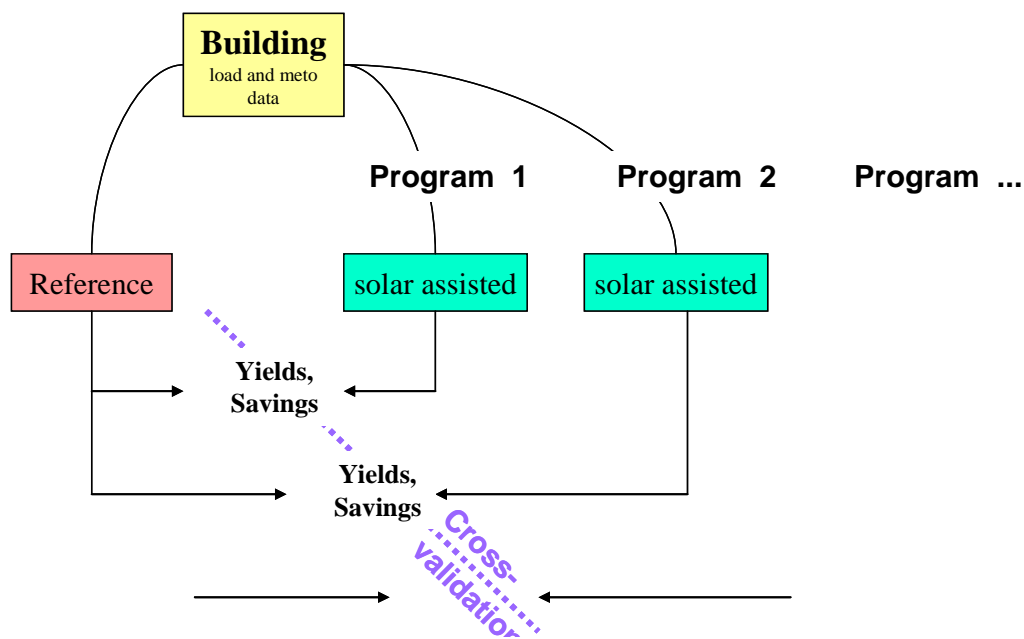

Figure 1: General approach for benchmarking the programs for solar assisted air-conditioning system simulation. In a preparatory step, a building is defined for the application of a chilled water system. In each case, a reference calculation for a conventional air-conditioning system is made and the results are compared to the solar assisted solution. The calculation is repeated with different simulation programs, thus allowing a cross-validation of selected performance parameters.

Definition of the model building: A building appropriate for the chilled water application (e.g., office building, usage mainly during day, sensible loads dominating) was defined. For the chilled water configuration, the model buildings defined in IEA Task 25 could be used, but had to be modified in size according to the available size of cooling equipment in the considered simulation programs. To give an example, in SOLAC two types of thermally driven chillers are implemented so far (35 kW absorption and 70 kW adsorption chilling capacity). For the comparison of the simulation results of the office building, the Task 25 office building had to be sized smaller in order to reduce the cooling loads.

Definition of the sites. Different typical climatic conditions should initially be considered to assess the validity of the comparison for different climatic areas. Some of the sites already defined and used in Task 25 were analysed for this purpose. With the ongoing exercise it was chosen to reduce the effort to one site definition.

Definition of the system configuration. A system configuration that could be simulated in all of the involved tools had to be defined. Choices to take for system definition mainly included the backup source (heat or additional compression chiller), the type of chiller, type of collector, hot and cold water storages and cooling tower.

Definition of a conventional non-solar supported system solution for reference calculations. In case of a chilled water system for air-conditioning of the office building, this conventional system is a gas heater for space heating in winter and an electrically driven compression chiller for cooling in summer.

Definition of the system size. For the chilled water system configuration, initial calculations were performed with EasyCool which allows fast evaluation of primary energy savings of differently sized systems. As target value it was chosen to apply a system size (collector area, storage sizes, etc.) allowing for at least 15% primary energy savings compared to the reference case. The identified system size was then transferred into the other simulation programs.

Definition of evaluation parameters for the cross-validation of the simulation results. The output of the simulation programs will be mainly compared on the basis of annual energy yields and a defined set of performance parameters.

1.3 Key performance parameters

In the evaluation of the simulation results, the following annual performance numbers may generally be applied. For the evaluation of simulation results only technical and energetic performance parameters are evaluated in this report.

Technical and energetic performance parameters

Net collector efficiency

This is the useful solar produced heat $Q_{\text{coll_use}}$, supporting the thermally driven cold production and the building heating, related to the radiation sum H_{sol} at the tilted collector aperture area:

$$\text{Net collector efficiency} = Q_{\text{coll_use}} / H_{\text{sol}} \quad \{0, \dots, 1\} \text{ or } \{0\% - 100\%\}$$

Specific collector yield

This is the useful solar produced heat $Q_{\text{coll_use}}$, related to the collector area A_{coll} in the considered evaluation period:

$$\text{Specific collector yield} = Q_{\text{coll_use}} / A_{\text{coll}} \quad [\text{kWh/m}^2]$$

Solar fraction

Quantification of the solar coverage on the total heat, used for driving the thermal chiller and required for building heating, thus:

$$\text{solar fraction} = Q_{\text{coll_use}} / Q_{\text{heat_total}} \quad \{0, \dots, 1\} \text{ or } \{0\% - 100\%\}$$

Solar fraction cooling

Quantification of the solar coverage on the total provided cooling by the thermally driven chiller compared to total provided cooling, thus:

$$\text{solar fraction cooling} = Q_{\text{cool_TD}} / Q_{\text{cool_total}} \quad \{0, \dots, 1\} \text{ or } \{0\% - 100\%\}$$

Savings in primary energy and CO₂ emissions

The annual amount of primary energy and CO₂ emissions, saved in comparison to the conventional non-solar reference system configuration

Annual operation hours of cooling equipment

Operation hours of chiller, operation hours of desiccant cooling mode, etc.

Economic performance parametersInvestment

Investment costs for planning, procurement and installation of the system. This figure is given as absolute value or as percentage of the investment costs of the conventional reference system

Annual costs

Annual costs for investment (by annuity method), maintenance and operation costs, including fuel costs and other operation costs, such as water consumption of the cooling tower etc. The costs are given as absolute value or as a percentage of the investment costs of the conventional reference system

Both, investment and annual costs are in general increasing with the size of the solar thermal plant and do not contain any information on the environmental achievements, thus, they do not allow by their own to decide for a reasonable system size.

Combined performance parameterCosts of saved primary energy

The combination of annual costs with the obtained savings in primary energy often allows the identification of an appropriate system size, since this value frequently shows a minimum as function of collector area and storage size. The costs of saved primary energy $C_{PE,saved}$ is defined as follows:

$$C_{PE,saved} = \frac{C_{sol,a} - C_{ref,a}}{E_{PE,ref,a} - E_{PE,sol,a}} \quad [€/ kWh_{PE}]$$

with $(C_{sol,a} - C_{ref,a})$ as difference in the annual costs between the solar assisted configuration and the reference configuration, and $(E_{PE,ref,a} - E_{PE,sol,a})$ as difference in the annual primary energy consumption between reference system and solar assisted system. The index a indicates the annual period in the assessment of this parameter. As boundary condition we require $(E_{PE,ref,a} - E_{PE,sol,a}) > 0$.

Positive specific costs per kWh saved primary energy in this definition means that the solar assisted air-conditioning causes additional costs in comparison to the conventional system solution.

2 Absorption chiller simulation benchmark

2.1 Office building simulation description

2.1.1 General Design

The chosen reference object is a two storey office building with a basement (see Figure 2 and Figure 3). The building is oriented along the east-west axis. The floor space on one level including the areas covered by internal walls and access facilities amounts to 309.9 m². The glazed area on the east facade amounts to 10 percent of the walls' surface area. On the south as well as on the north facade the respective value is 38 %, whereas on the west facade no windows are assumed. The western wall of the building is adjacent to a neighbouring building. With the exception of the number of storeys, the building shell and geometry follow very closely the reference office building, designed within IEA-SHC Task25 (Solar Air-Conditioning of Buildings). Although consisting of two storeys, the building is modelled as a single zone building. In comparison to the Task25 office model the peak cooling load is reduced to approximately 30 to 40 kW (depending on the location) and is thus more applicable for simulation with medium sized chiller systems. The modification of the building model was undertaken by Franciska Klein during her stay at Fraunhofer ISE.

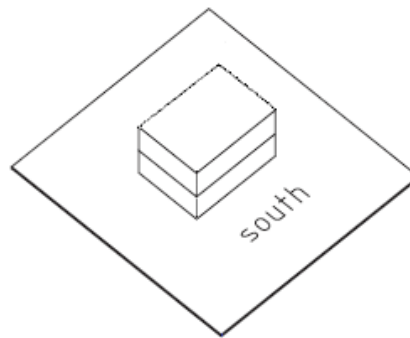
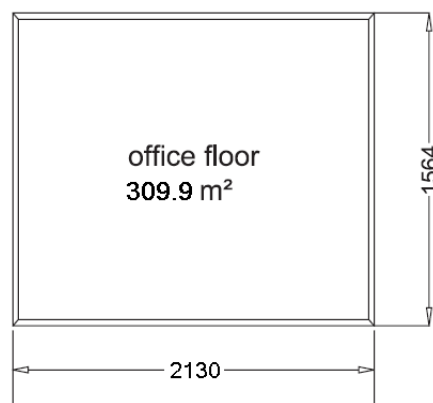

Figure 2: Axionometry of the reference office building



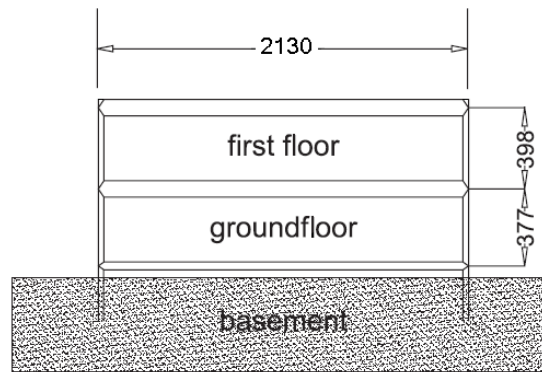

Figure 3: Geometry and dimensions of reduced reference office building

The corresponding values specifying the building dimensions are listed in Table 1.

Table 1: Areas and volumes of the downsized reference office building – first iteration

	Floor space [m ²]	Volume [m ³]	Facade area (North&South) [m ²]	Facade area (East&West) [m ²]	Internal walls		
					length [m]	height [m]	(both sides) [m ²]
ground floor	310	985	85	62.25	53.33	3.18	339.2
first floor	310	985	85	62.25			339.2
total	620	1970	170	124.5			678.4

2.1.2 Construction details

The wall structure is similar to the structure used for the Task25 reference building. Wall construction and U-values are listed in Table 2.

Table 2: Specification of wall characteristics

Assembly	Wall type (TRNSYS)	Thickness [m]	U-value [W/m ² K]
Roof	AWAND_L	0.328	0.315
External Wall	AWNORM	0.320	0.345
Floor Slab	GEDNORM	0.310	0.354
Ground floor basement	KDNORM	0.780	0.318
Internal walls	TREWLEICHT	0.130	0.364

Windows are assumed double-glazed with a U-value of 1.1 W/m²K and a g-value of 0.598.

Table 3 gives a summary of the glazed area per façade orientation.

Table 3: Glazed area of external walls

Facade orientation	Glazed area [%]
East	10.0
South	37.9
North	37.9
West	No windows

2.1.3 Internal loads

Internal loads are assumed to be due to occupation, office equipment and lighting.

Occupation

In the case of full occupancy, there is a total number of 21 people being simultaneously present in the building. On Saturdays working activities and a corresponding reduced occupancy profile are restricted to the first floor, whereas the other floor is assumed to be unoccupied. On Sundays no people are assumed to be inside the building. The overall occupancy profile is displayed in Figure 4. Per person a rate of heat dissipation of 100 W is assumed (Degree of activity – seated at rest: sensible heat of 60 W/Person and latent heat of 40 W/Person).

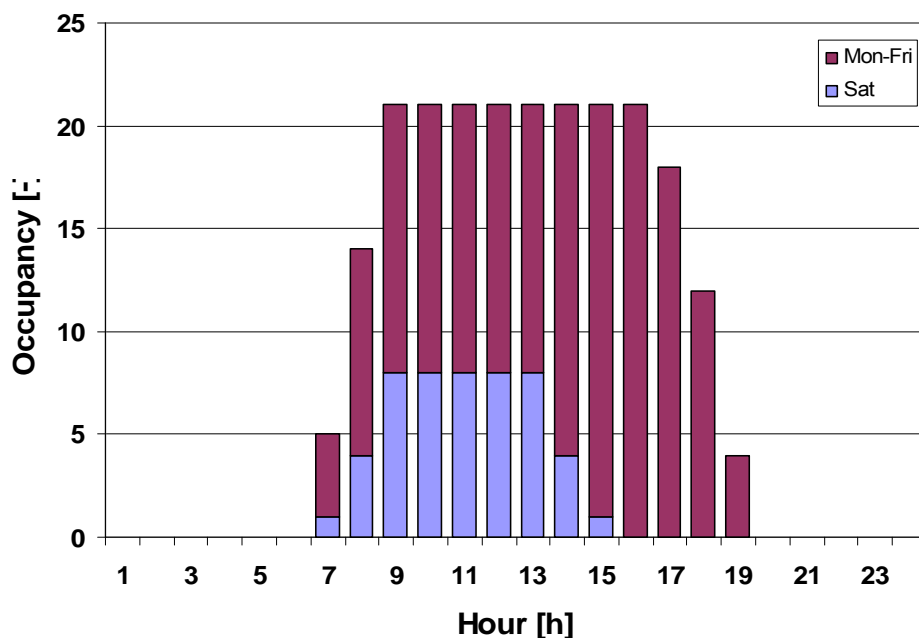

Figure 4: Occupancy of reference office building

Office equipment

The rate of heat dissipation from office equipment depends on the operational status of the devices and is thus correlated to the occupancy profile in the offices. It is assumed that 70%

of the work places are equipped with a PC (including a monitor) with a heat dissipation rate of 230 W per unit.

Artificial light

The floor space is divided into two sections. One section is assumed to be illuminated only by daylight and the other one only by artificial light. The lighting in the latter case is correlated to the working hours and thus to the occupancy profile. The term “working hour” applies to all time intervals in which at least one person is present in the office rooms. In these intervals the lighting is assumed to be generated by energy saving lamps (heat dissipation: 2 W/m²).

Ventilation and Infiltration

Infiltration is assumed constant at a value of 0.2 1/h. Ventilation corresponds to the occupancy of the building and covers the hygienic air change of 30m³/h per person.

Target values for zone temperatures

The targeted values for zone temperature are the minimum temperature of T=21°C in winter and the maximum allowed temperature of T=26°C in summer. The heating and cooling loads are calculated in order to meet these targeted values.

2.2 Cooling and heating loads of building simulation

2.2.1 Initial building simulation for four different locations

Building simulations were performed for the following four locations:

- Freiburg, Madrid, Perpignan and Palermo

The results of the first building simulations are presented in Figure 5 and Figure 6.

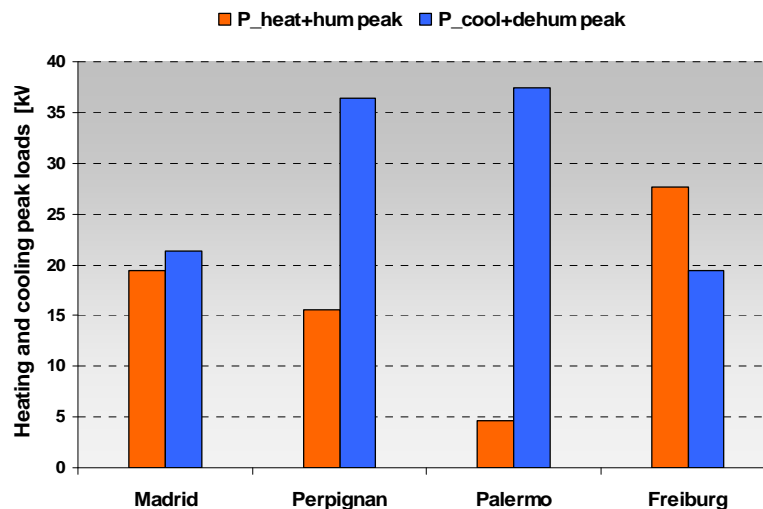

Figure 5: Peak cooling and heating power of the reference office building for four locations

Figure 5 shows simulation results of the required peak cooling and heating power [kW] of the downsized reference office building for the four different locations. Maximum cooling demand including dehumidification is highest in Perpignan and Palermo reaching slightly more than 35 kW. In these two locations the required cooling power associated with dehumidification is significant (29% of peak cooling power for Perpignan and 38% for Palermo). Cooling and dehumidification demand in Freiburg and Madrid lie around 20kW with sensible cooling

constituting the main part. Heating is rather insignificant in Palermo and most significant in Freiburg.

The profile of required cooling power was assumed to be applicable for the simulation of cooling provided by a 35kW absorption chiller.

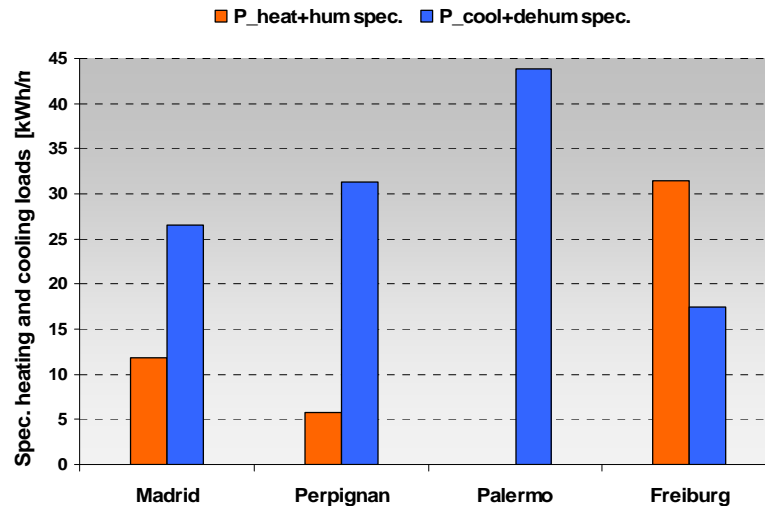

Figure 6: Specific heating and cooling loads of reference office building for four locations

Figure 6 shows the annual specific heating and cooling loads [kWh/m^2] of the reference office building. The simulated annual specific cooling load is highest in Palermo where heating is insignificant on the annual scale. The annual specific cooling load for Madrid and Perpignan is similar with a higher cooling share in Perpignan. In Freiburg heating is more significant than cooling.

For purpose of the simulation comparison two iterations were performed:

In the first simulation run the Perpignan load file of the downsized Task 25 reference office building was applied with a system configuration characterised by the 35 kW chiller being able to cover all cooling loads. A gas heater backup was assumed for cooling and heating purpose. Simulations were performed with EasyCool, SolAC and INSEL. Analysing the simulation results it was found that the 35 kW chiller was oversized for the given building load file.

Therefore, a second simulation run was undertaken – this time an up-scaled Palermo load file dominated by cooling operation in summer and a insignificant share of heating demand was used. For this simulation run, a parametric analysis on system parameters was also performed. This second simulation run represents the main scope of this analysis.

2.2.2 Load file description of initial Perpignan simulation – 1st iteration

Figure 7 shows the area specific monthly heating or cooling load and the specific global radiation on the collector area of the Perpignan load and weather data.

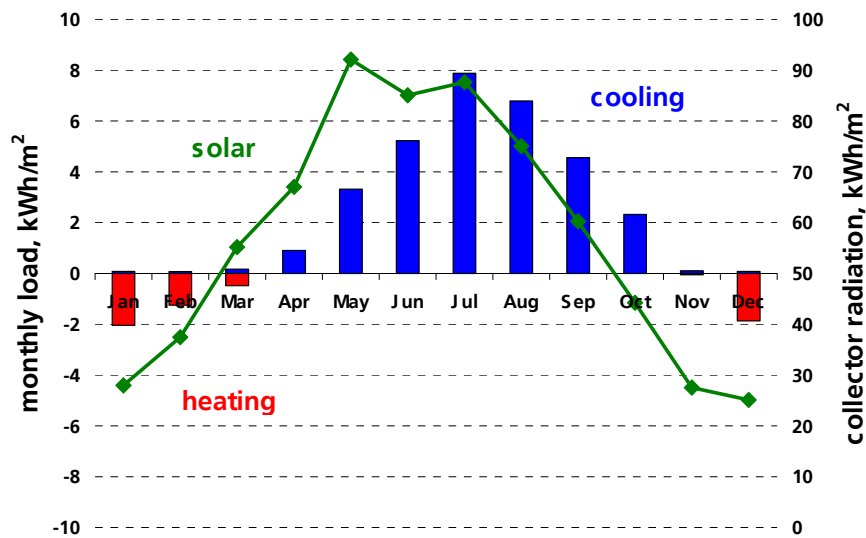

Figure 7: Monthly specific cooling load (left axis) and solar irradiation on collector surface (right axis) of the reference office building in Palermo

Cooling load is dominating. However, in winter also a significant share in heating load is observed. The collector radiation has a maximum in May when cooling loads are still moderate. It is still high in July (88 kWh/m²) which is the month of maximum cooling load (7.9 kWh/m²). On an accumulated monthly base, a quite good simultaneity between collector irradiation and building loads is given.

2.2.3 Load file description of final Palermo simulation – 2nd iteration

Figure 8 shows the area specific monthly heating or cooling load and the specific global radiation on the collector area of the Palermo load and weather data.

For the Palermo load file, cooling loads are dominating. In winter, there is no significant heating share. The area specific cooling load reaches a maximum of 8.9 kWh/m² in August. The specific collector radiation is much higher in Palermo climate, with a maximum of 206 kWh/m² in July and in general more evenly distributed over the whole year. On an accumulated monthly base, again, a quite good simultaneity between collector irradiation and building loads is given.

For Palermo load simulations the building is assumed to be by a multiplication factor of 1.5 bigger (930 m²) than the Perpignan building (620 m²). The building loads are therefore multiplied by this factor in order to allow for a better application with a 35 kW chiller in the simulation comparison.

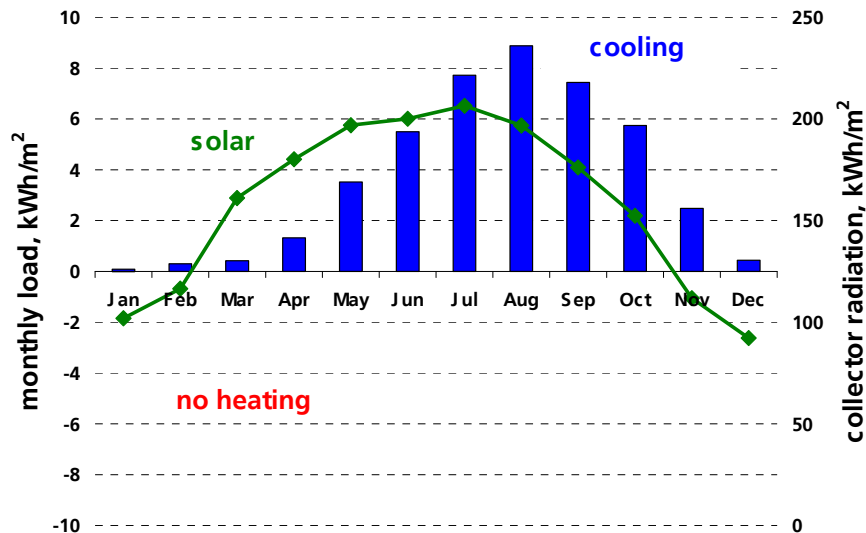

Figure 8: Monthly specific cooling load (left axis) and solar irradiation on collector surface (right axis) of the reference office building in Palermo

2.3 System definition

2.3.1 System definition of Perpignan simulation – 1st iteration

The chilled water system for the Perpignan system simulation consists of the following system elements. The system layout is given in Figure 9.

- solar collector field (115 m² vacuum tube collector)
- heat exchanger between hot water buffer storage and collector circuit
- hot water buffer storage (3 m³)
- absorption chiller (35 kW Yazaki WFC10)
- wet cooling tower (constant temperature approach)
- external backup heater: gas heater for heating and cooling operation
- pumps

The primary (collector) and the secondary (hot water buffer storage) solar circuit are separated by a heat exchanger. Hot water from the hot water storage tank may be fed to a) the absorption chiller generator to provide cooling or b) directly to the building in case of heating demand.

In case the cooling or heating load cannot be met by solar means alone, an external backup heater is foreseen for supplementary heating of the hot water loop to the generator (cooling) or building (heating). A system configuration with backup heater for cooling purposes was first chosen as this configuration is possible to implement in the maximum number of simulation tools. In particular, SolAC is restricted to a backup heater system configuration.

The backup heater is arranged in parallel to the hot water buffer storage. In case the backup heater is operating, the hot water circuit fed by the backup heater can be decoupled from the hot water buffer storage, preventing the hot water buffer storage from being charged by the

backup heat source. During operation of the backup heater the hot water storage can then be charged via the collector loop.

Heat rejection is obtained by means of a wet cooling tower. For reasons of simulation simplification the heat rejection unit was not specifically simulated, but a constant cooling water inlet temperature of 27°C to the absorption chiller was assumed. Cooling tower operation was correlated to absorption chiller operation hours. Also for reasons of simulation simplification, no cold water buffer storage was included in this first simulation run.

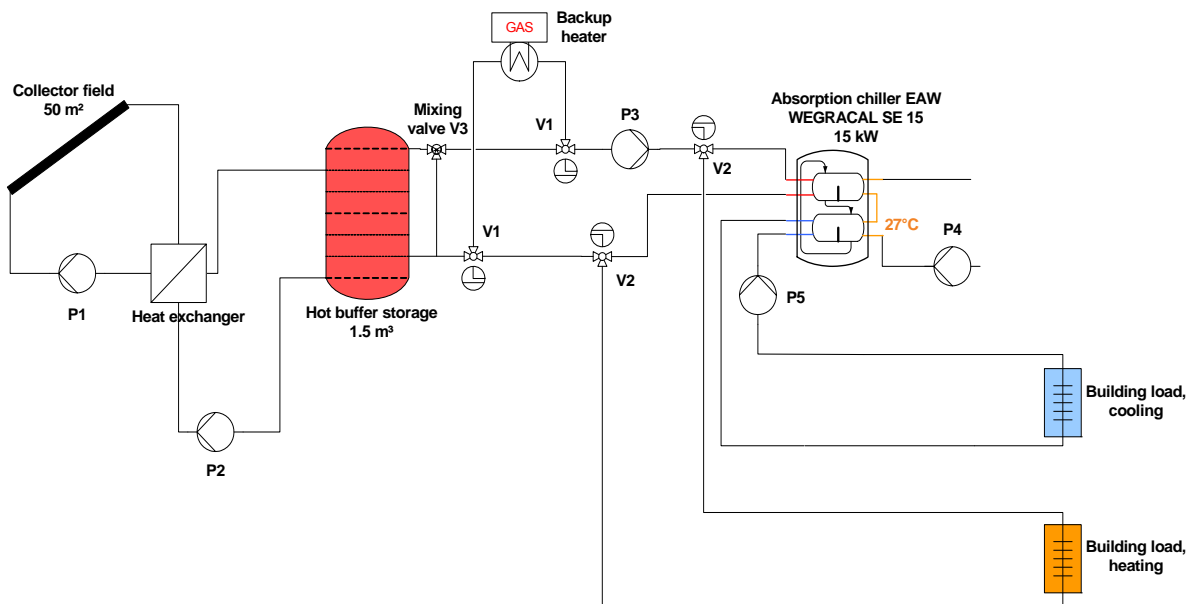

Figure 9: Schematic of Perpignan system configuration for the simulation comparison
Main dimensions of the involved system components are given in Table 4.

Table 4: System dimensioning for the Perpignan simulation

Perpignan			
Specification		Dimensioning	
Collector type	Evacuated tube collector	Collector area [m ²]	115 m ²
Heat exchanger	Counter flow HX	HX effectiveness [-]	0.9
Hot buffer storage, loss coefficient [W/m ² K]	0.8	Storage volume [m ³]	3 m ³
Backup heat source, Conversion coefficient [-]	Gas heater, $\eta_{GH} = 0.95$	Heating capacity [kW]	50 kW
Reference system			
Vapour compression chiller	40 kW	COP	3.0
Gas heater	20 kW	η_{GH}	0.95

Chiller

For all simulations a 35kW Yazaki WFC 10 lithium bromide/ water absorption chiller model was applied as a model of this chiller is available in SolAC and INSEL. EasyCool simulations are performed with a constant annual COP representing the chiller.

Collector type

For the simulation of Perpignan climate an evacuated tube collector was defined. The type of collector (Ritter CPC INOX) used in the simulation is specified in Table 5. A model of the collector is available in INSEL.

Table 5: Collector specification

Collector type	Evacuated tube collector
Manufacturer	Ritter Solar
Name	CPC INOX 12
Aperture area [m ²]	2
Optical efficiency η_0 [-]	0.642
Linear loss coefficient [W/m ² K]	0.890
Quadratic loss coefficient [W/m ² K ²]	0.001
K50, long	0.9
K50, trans	1.0

2.3.2 System definition of Palermo simulation – 2nd iteration

The chilled water system for the Palermo system simulation shall consist of the following elements. The system layout is given in Figure 10.

- solar collector field (115 m² flat plat collector, double glazed)
- heat exchanger between hot water buffer storage and collector circuit
- hot water buffer storage (3 m³)
- absorption chiller (35 kW Yazaki WFC10)
- wet cooling tower (constant temperature approach)
- cold water buffer storage (1.5 m³)
- external backup heater: gas heater for winter operation
- external backup cooling: compression chiller for summer operation
- pumps

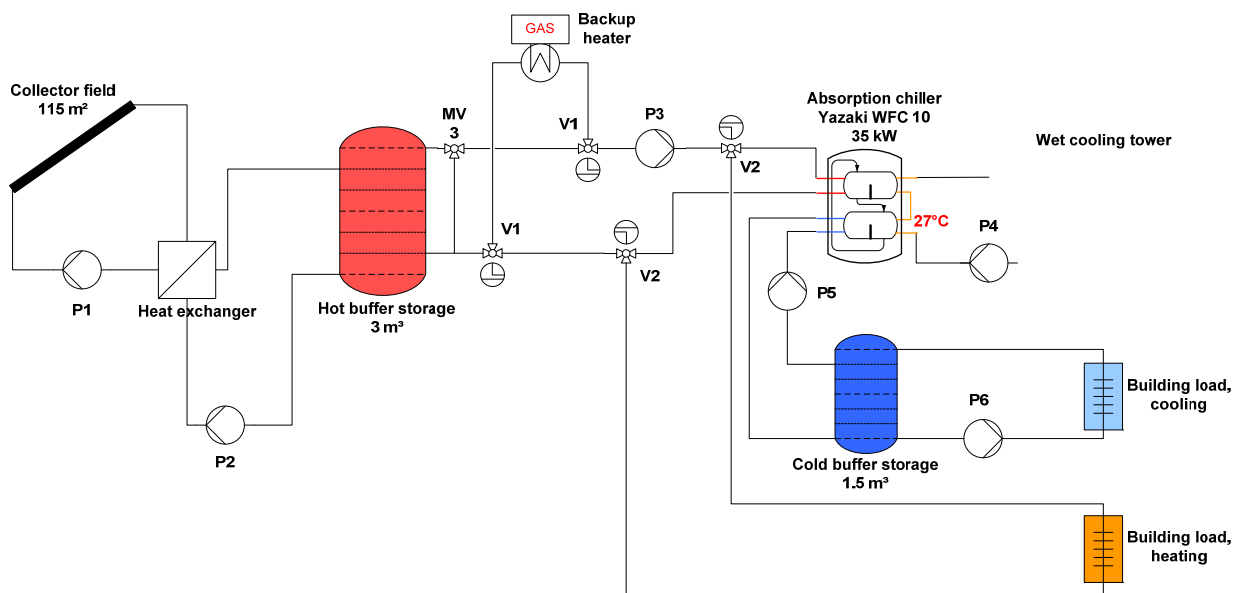

Figure 10: Schematic of Palermo system configuration for the baseline simulation

Again, the primary (collector) and the secondary (hot water buffer storage) solar circuit are separated by a heat exchanger. Hot water from the hot water storage tank may be fed to the absorption chiller generator to provide cooling or directly to the building in case of heating applications.

For cooling operation a backup compression chiller is foreseen. This backup chiller is not explicitly simulated – the cooling loads not covered by the absorption chiller operation are assumed to be covered by the conventional backup which is assumed to be characterized by a COP of 3.5. Due to the low heating load in the Palermo building simulation, the backup gas heater for winter application remains virtually unused.

Heat rejection is obtained by means of a cooling tower. Again, a constant temperature approach is (27°C cooling tower outlet) is followed for simulation simplification.

The absorption chiller cold water circuit and the building cold water circuit are separated by a cold water buffer storage. This storage is incorporated in the system configuration in order to allow a higher share of absorption chiller operation and to facilitate simulation stability due to the hydraulic separation of the two cold water circuits.

Table 6: System dimensioning for Palermo simulation

Palermo			
Specification		Dimensioning	
Collector type	Flat plate collector	Collector area [m ²]	115 m ²
Heat exchanger	Counter flow HX	HX effectiveness [-]	0.9
Hot buffer storage, loss coefficient [W/m ² K]	0.8	Storage volume [m ³]	3 m ³
Cold buffer storage, loss coefficient [W/m ² K]	0.5	Storage volume [m ³]	1.5 m ³
Backup heat source, Conversion coefficient [-]	Gas heater, $\eta_{GH} = 0.95$	Heating capacity [kW]	10 kW
Reference system			
Vapour compression chiller	40 kW	COP	3.5
Gas heater	20 kW	η_{GH}	0.95

Chiller

As a first approach the 35kW Yazaki WFC 10 lithium bromide/ water absorption chiller model was applied as a model of this chiller. A model is available in SolAC, INSEL, TRNSYS and TRANSSOL. EasyCool simulations are performed with a constant annual COP of 0.69. As no model of the 35kW Yazaki WFC10 chiller is available in SPARK, simulations were performed with an absorption chiller in a similar capacity range, the 30 kW EAW absorption chiller. SPARK was therefore included in the simulation comparison, however results can only be assessed with respect to the order of magnitude.

Collector type

For the simulation of Palermo climate a double-glazed flat plate collector was defined. Table 7 gives the collector specification of the SchücoSol U.5 DG flat plate collector used in the simulation.

Table 7: Collector specification

Collector type	Flat plat collector, double-glazing
Manufacturer	Schüco International KG
Name	SchücoSol U.5 DG
Aperture area [m ²]	2.474 m ²
Optical efficiency η_0 [-]	0.793
Linear loss coefficient [W/m ² K]	2.92
Quadratic loss coefficient [W/m ² K ²]	0.0131
K50, long	0.906
K50, trans	0.906

2.4 System control strategy

The system control strategy was worked out by Antoine Dalibard and Paul Kohlenbach.

The definition of a common control strategy is important for the more advanced simulation tools INSEL, TRNSYS, TRANSSOL and SPARK. It is not possible to include detailed control strategies in the pre-design tools included in the comparison (SolAC and EasyCool) as these mainly solve energy balance calculations.

2.4.1 System control of Perpignan simulation – 1st iteration

The control strategy used for Perpignan simulation is very similar to the one used for Palermo. The main difference is that there is no cold storage tank. So the evaporator of the chiller is directly connected to the load. There is no pump P6. This caused a lot of problem since the cooling power delivered by the chiller is much higher than the load. Also, the chiller can be run only when there is cooling demand.

Furthermore, the starting temperature of the chiller was set to 85°C and the control of the pump P3 was a bit different (ON when $T_{st_top} > T_{chiller} + 4K$, OFF when $T_{st_top} < T_{chiller}$).

Due to stability/convergence problems, the return temperature of the chilled water was set constant to 12°C.

2.4.2 System control of Palermo simulation – 2nd iteration

The final control strategy for the Palermo baseline simulation is described in the following.

Nomenclature

- Gt: Irradiation on the collector titled surface [W/m²]
- Tchiller: Starting heating temperature of the chiller [°C]
- Tcol: Outlet temperature of the collector field [°C]
- Tst_hot_top: Temperature at the top of the hot storage [°C]
- Tst_cold_bot: Temperature at the bottom of the cold storage [°C]
- Vdot_1: Volume flow rate of the pump P1 [liters/hour]
- Vdot_2: Volume flow rate of the pump P2 [liters/hour]
- Vdot_3: Volume flow rate of the pump P3 [liters/hour]
- Vdot_4: Volume flow rate of the pump P4 [liters/hour]
- Vdot_5: Volume flow rate of the pump P5 [liters/hour]
- Vdot_6: Volume flow rate of the pump P6 [liters/hour]
- Qheat: Heating load of the building [W]
- Qcool: Cooling load of the building [W]

Control of the solar loop (pump P1)

The solar loop is the circuit between the collectors and the heat exchanger. For the control of the solar pump (P1), an irradiation differential controller has been chosen:

The pump P1 is switched ON: if $G_t > 300 \text{ W/m}^2$
 The pump P1 is switched OFF: if $G_t < 200 \text{ W/m}^2$
 The volume flow rate used is $\dot{V}_{1} = 4300 \text{ l/hr}$ (38 l/hr.m²)

Control of the pump P2

The storage loop is the circuit between the heat exchanger and the hot storage tank. To control the pump P2, a temperature differential controller is used:

The pump P2 is switched ON: if (P1 is ON) and ($T_{col} > T_{st_hot_top} + 4K$)
 The pump P2 is switched OFF: if (P2 is OFF) or ($T_{col} < T_{st_hot_top} + 2K$)
 The volume flow rate used is $\dot{V}_{2} = \dot{V}_{1} = 4300 \text{ l/hr}$

Control of the hot water loop (pump P3 and valves V1, V2, V3)

The hot water loop is:

- In heating mode: the circuit between the hot storage tank and the heating distribution system of the building
- In cooling mode: the circuit between the hot storage and the chiller.

Control of the valve V2:

The valve V2 is opened if $Q_{heat} > 0$ (heating mode)
 The valve V2 is closed if $Q_{heat} = 0$ (cooling mode)

Heating mode

In heating mode, the hot water supply temperature to the heating distribution system is 60°C.

Control of the valve V1:

The valve V1 is closed if $T_{st_hot_top} \geq 64^\circ\text{C}$ (the hot water is taken from the tank)
 The valve V1 is opened if $T_{st_hot_top} < 60^\circ\text{C}$ (the gas heater runs)

The return temperature of the heating system is set constant to 50°C. In both cases, the pump P3 runs with a variable volume flow according to the demand.

Control of the mixing valve V3:

The mixing valve V3 mixes the return water with the water from the tank to assure a constant supply temperature (60°C) when $T_{st_hot_top} > 60^\circ\text{C}$.

Cooling mode

In cooling mode, the valve V1 is always closed, since there is a cold back-up.
The starting temperature if the chiller is set constant ($T_{\text{chiller}} = 80 \text{ }^\circ\text{C}$)

Control of the pump P3:

The pump P3 is ON: if ($T_{\text{st_hot_top}} \geq T_{\text{chiller}} + 15 \text{ K}$) and
 ($T_{\text{st_cold_bot}} > 3^\circ\text{C}$)

The pump P3 is OFF: if ($T_{\text{st_hot_top}} < T_{\text{chiller}}$) or ($T_{\text{st_cold_bot}} < 3^\circ\text{C}$)

In cooling mode, the pump P3 runs with a constant volume flow:

$$V_{\text{dot}_3} = V_{\text{dot}_2} = V_{\text{dot}_1} = 4300 \text{ l/hr}$$

NB: The mixing valve V3 is not used in cooling mode

Control of the chilled and cooling water loops (pump P4,P5)

The pumps P4 and P5 are controlled like the pump P3 in cooling mode:

Control of the pumps P4,P5:

The pumps P4,P5 are switched ON: if P3 is ON

The pumps P4,P5 are switched OFF: if P3 is OFF

The volume flow rate for the pump P4 is constant $V_{\text{dot}_4} = 18360 \text{ l/hr}$

The volume flow rate for the pump P5 is constant $V_{\text{dot}_5} = 5508 \text{ l/hr}$

Control of cooling load loop (pump P6)

The pump P6 is used to distribute the chilled water from the cold storage tank to the building.

Control of the pump P6:

The pump P6 is switched ON: if ($Q_{\text{cool}} > 0$) and ($T_{\text{st_cold_bot}} < 12$)

The pump P6 is switched OFF: if ($Q_{\text{cool}} < 0$) or ($T_{\text{st_cold_bot}} > 12$)

The return temperature of the cooling system is set constant to 12°C . The pump P6 runs with a variable volume flow according to the demand.

Parameters for electricity consumption

For the calculation of the parasitic energy consumption, the values given in Table 8 have been used for the pumps. The manufacturer of the Yazaki WFC-SC10 chiller specifies a hot water flow rate of $8.6 \text{ m}^3/\text{hr}$. For the simulation the flow rate of hot water was chosen at 50% of this or $4.3 \text{ m}^3/\text{hr}$. This was done because the flow rate through the solar field would have been unnecessarily high otherwise. Even with the assumed $4.3 \text{ m}^3/\text{hr}$ it is at the upper limit of recommended values ($37 \text{ l/m}^2/\text{hr}$, where high-flow fields are recommended at 40 l/hr/m^2 at maximum). Flow rates of pumps P1, P2 and P3 have been assumed of equal flow to match temperatures and simplify error potential in the simulations with different softwares.

Table 8: Specification of pump power consumption

	Palermo (Yazaki 35 kW)	
	Vdot [m ³ /h]	P_elec [kW]
Pump P1	4.3	0.215
Pump P2	4.3	0.215
Pump P3 (var.)	4.3 (max)	0.215 (max)
Pump P4	18.4	0.92
Pump P5	5.5	0.27
Pump P6 (var.)	8.6 (max)	0.43 (max)

For the electricity consumption of the cooling tower ventilator and the internal pump of the chiller, the values of the manufacturers have been used. For the cooling tower, the value is from the AXIMA wet cooling tower EWK 064/03 catalog. For the internal pump, the value is from Yazaki WFC10 technical data.

Table 9: Specification of power consumption of further auxiliary equipment

	Palermo (Yazaki 35 kW)
	P_elec [kW]
Ventilator cooling tower	0.55
Internal pump chiller	0.21

2.5 Simulation results and comparison

2.5.1 Perpignan simulation – comparison of first results

The first system simulation was undertaken using the Perpignan load file and system configuration. It is included in the report as it allows including the pre-design tool SolAC in the comparison. The following participants were contributing with simulations:

- SolAC absorption chiller simulation: Marco Zetsche
- INSEL absorption chiller simulation: Antoine Dalibard
- EasyCool absorption chiller simulation: Constanze Bongs

Further, the reference system simulation was undertaken in TRNSYS and EasyCool.

- TRNSYS reference simulation: Panagiotis Tsekouras
- EasyCool reference simulation: Constanze Bongs

Results of the chilled water system simulations are presented in Table 10.

Table 10: Simulation results of key performance parameters of 1st iteration Perpignan simulation

	SolAC	INSEL	EasyCool
$Q_{\text{coll_use}}$ [MWh/a]	28.7	47.3	30.7
$Q_{\text{gas_backup}}$ [MWh/a]	9.7	8.9	5.4
Q_{cool} [MWh/a]	24.0	31.6	19.4
$\eta_{\text{coll_eff}}$ [-]	0.15	0.25	0.16
Spec. collector yield [kWh/m ²]	250	415	267
solar fraction cooling [-]	0.75	0.84	0.86
W_{el} [MWh _{el} /a]	2.4	1.9	5.6

Comparing the energetic parameters of system simulations, the two pre-design tools SolAC and EasyCool show similar results concerning the thermal parameters. The amount of provided cooling in the SolAC simulation is however higher than the demand by the building load which is met in the EasyCool simulation. The similar results may be explained by the similar method of calculation of the two tools – in both energy balances are calculated and transient system behaviour is not taken into account.

In terms of electricity consumption EasyCool results are very high. The tendency of EasyCool to estimate high electricity consumption is known as a tool-specific problem, especially due to the assumption of constant speed pumps running at the specified maximum power once the system is running.

INSEL simulations show quite different results and revealed weaknesses in system configuration and sizing.

Initial system sizing was undertaken in EasyCool. As the defined system configuration has a thermal backup, all cooling is assumed to be covered by the thermal chiller. In EasyCool the chiller is automatically sized to cover the maximum cooling load. Due to the approach to use a constant annual COP, no part load behaviour is taken into account. Therefore, there is a tendency to oversize the chiller.

In contrast, INSEL simulations revealed that the specified system was oversized for the load file. Due to the strict control of the pump P3 (only 4K difference), the chiller could not be used often. The collector field was most of the time in stagnation and therefore no possibility to make use of the solar heat was present. When the chiller runs, it delivers much more cooling power than the cooling demand actually needed. In order to make a better use of the chiller (control the cooling load and have the possibility to use the chiller without having a cooling demand), we put a cold storage between the load and the chiller in the second simulation run.

Results of the reference system simulation are presented in Table 11.

Table 11: Simulation results of 1st iteration Perpignan reference system simulation

	EasyCool	TRNSYS
$Q_{\text{gas_backup}}$ [kWh/a]	3530	3533
Q_{cool} [kWh/a]	19370	19373
W_{el} [kWh _{el} /a]	7620	7367

Results for gas backup utilization and compression cooling are almost identical for both TRNSYS and EasyCool simulations. Differences in electricity consumption amount to around 3% only – these are mainly due to the fact that pressure drop in the piping system is taken account of in the TRNSYS simulation. As the simulation is performed on a less detailed level than the chilled water system simulation for both simulation tools - gas heater and compression chiller taken account of by a constant COP model - it is quite clear to reach similar results.

The following **conclusions** can be drawn from the first iteration of the simulation exercise:

- The reference system simulation in EasyCool and TRNSYS show both similar results with a maximum deviation of 4% in electricity consumption. This is expected as both tools treat the reference simulation with a similar level of detail.
- SolAC and EasyCool show similar results on the thermal side. Again, both system calculations are on a similar level of detail. EasyCool results seem to overestimate electricity consumption.
- INSEL results are of a much higher level of detail also reflecting system transients and chiller part load behaviour. Major shortcomings in the simulation setup are revealed in this detailed simulation. This implies especially the oversizing of the chiller being able to cover the maximum load, oversizing of the solar field and the need of a cold storage.

Hence, the simulation exercise went into a second iteration with a load file characterized by a higher cooling demand and a downsized collector field.

2.5.2 Palermo simulation – comparison of main results

The main results of the simulation comparison were generated in the second simulation run with the Palermo load file and an altered system setup. Main differences to the first simulation run are the inclusion of a cold storage and a compression chiller backup. The latter allows determining the size of the chiller decoupled from the maximum load in EasyCool calculations. As a configuration with a compression chiller backup is not available in SolAC, it was not included in the second simulation run. Simulations were performed for the following tools and by the following contributors:

- INSEL: Antoine Dalibard
- TRNSYS: Paul Kohlenbach

- TRANSOL: Ignasi Gurruchaga
- SPARK: Olivier Marc
- EasyCool: Constanze Bongs

SPARK simulations were performed with a performance map model of the EAW 30kW absorption chiller as a model of the Yazaki WFC10 35kW absorption chiller was not available in SPARK. Further, the heat exchanger between the primary and secondary solar loop was not included in the simulation. Thus, the SPARK simulations can only be evaluated according to their order of magnitude.

The reference system simulation was again performed with TRNSYS and EasyCool by Panagiotis Tsekouras (TRNSYS) and Constanze Bongs (EasyCool).

Baseline simulation

Results from the baseline simulation as described under 2.3.2 are given in Table 12.

Table 12: Simulation results of key performance parameters of the base Palermo simulation

	Mean (a,b,c) +/- delta max.	Mean tot +/- delta max.	INSEL (a)	EasyCool (b)	TRANSOL (c)	SPARK (d)	TRNSYS (e)
$Q_{coll\ use}$ [kWh/a]	39623 +/- 6%	44068 +/- 21%	37250	39648	41971	48253	53218
$Q_{cool\ ACH}$ [kWh/a]	27244 +/- 6%	29039 +/- 11%	25865	26955	28911	31219	32244
$Q_{cool\ CCH}$ [kWh/a]	13624 +/- 14%	40821 +/- 30%	15316	13813	11742	9534	8506
$\eta_{coll\ eff}$ [-]	0.18 +/- 6%	0.20 +/- 21%	0.17	0.18	0.19	0.22	0.24
Spec. collector yield [kWh/m ²]	345 +/- 6%	383 +/- 21%	324	345	365	420	463
solar fraction cooling [-]	0.67 +/- 7%	0.69 +/- 14%	0.63	0.66	0.71	0.77	0.79
$W_{el\ backup}$ [kWh _{el} /a]	3893 +/- 14%	3366 +/- 30%	4376	3947	3355	2724	2430
$W_{el\ tot}$ [kWh _{el} /a]	7923 +/- 9%	7368 +/- 13%	7212	8353	8205	6595	6476

The simulation results can be classified into two groups. Simulations with INSEL, EasyCool and TRANSOL (highlighted in grey) show very similar simulation results. The deviation between the different simulations is around 6% on the thermal system parameters. The overall electricity consumption calculated by the different simulation tools varies about 10%.

Results analysis shows that the amount of used solar heat is a good indicator for simulated thermal system performance. SPARK and TRNSYS simulations show the largest deviations from the mean of all simulations for all parameters. Here, the used solar heat is highest, giving a high share in cooling provided by the absorption chiller, high solar fraction and a resulting lower overall electricity consumption. The main reason for the larger deviation must mainly be found in the simulation of the solar system which is explained in more detail in the individual sections.

Table 13 again gives the results of the Palermo reference system simulation. Again, the deviations between the TRNSYS and EasyCool simulations are quite small – with a maximum range of 4% concerning electricity consumption. Once more, the variation range decreases with the complexity of the simulation exercise.

Table 13: Simulation results of 2nd iteration Palermo reference system simulation

	EasyCool	TRNSYS
$Q_{\text{gas_backup}}$ [kWh/a]	10	9
Q_{cool} [kWh/a]	40750	40753
W_{el} [kWh _{el} /a]	12720	12188

Two sensitivity analyses were conducted in order to understand the influence of the different system simulations on two parameters. As a system control parameter the chiller starting temperature was chosen, while chiller hysteresis ($dT=15K$) was kept constant. As a system configuration parameter collector area was varied. The following range of variations was applied in the simulations:

- Chiller starting temperature: 80°C (baseline), 85°C, 90°C
- Collector area: 90 m², 115 m² (baseline), 140 m²

Simulation results are presented by the following parameters representing the solar performance, cooling performance and energy performance of the system.

- Solar: Specific collector yield
- Cooling: Solar fraction cooling
- Energy: Electricity consumption

Due to the insignificant amount of heating in the load file and the resulting coverage of heating demand by the solar system, the energy performance in terms of primary energy saved can be directly correlated to the amount of electricity saved. Therefore, in this particular case the electricity consumption is the main measure to characterize system performance.

Variation of collector area – simulation results

The results of the variation of the collector area are shown in Figure 11 to Figure 13. In all simulations the specific collector yield decreases with an increase in collector area. In the TRNSYS simulation, the rate of decrease of the specific collector yield is the smallest – that is the increase in useful solar heat is the largest. This reflects in the strongest increase in the solar fraction of cooling and the strongest decrease in electricity consumption as the backup chiller provides less cooling. For the thermal side, this is true for all simulations but the one conducted with INSEL. The main reason for this is a more detailed system control taking into account stagnation of the solar collector as well as the differences in the chiller models. This is specified in more detail in the section “Results interpretation”.

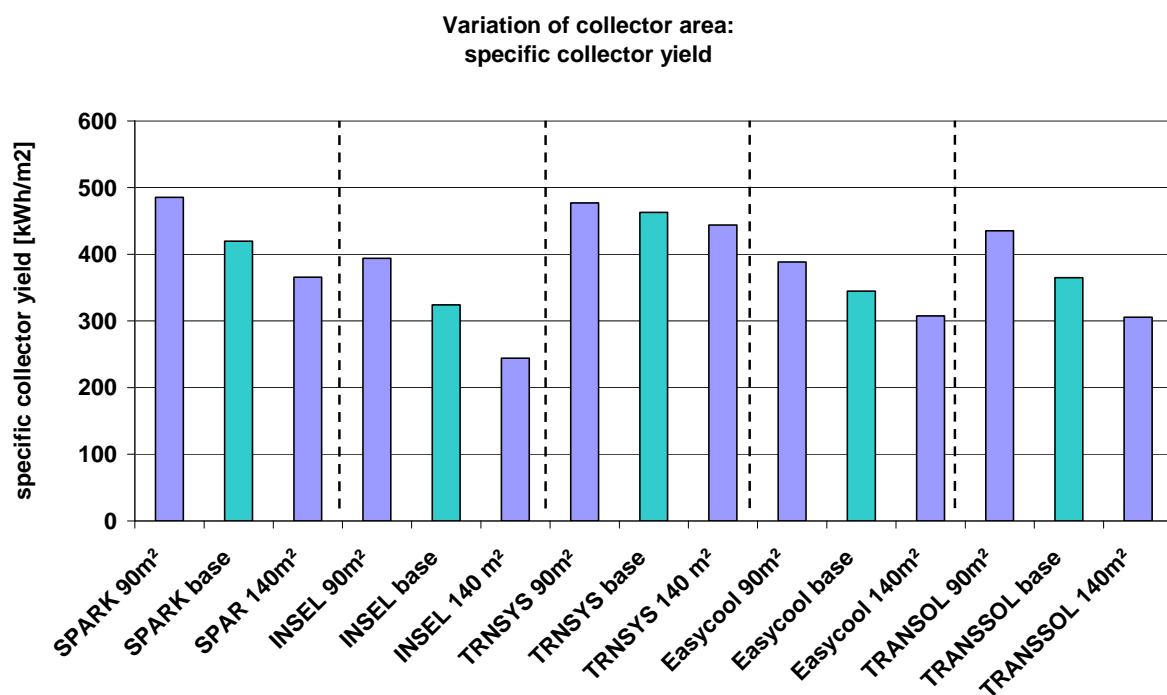

Figure 11: Specific collector yield / variation of collector area

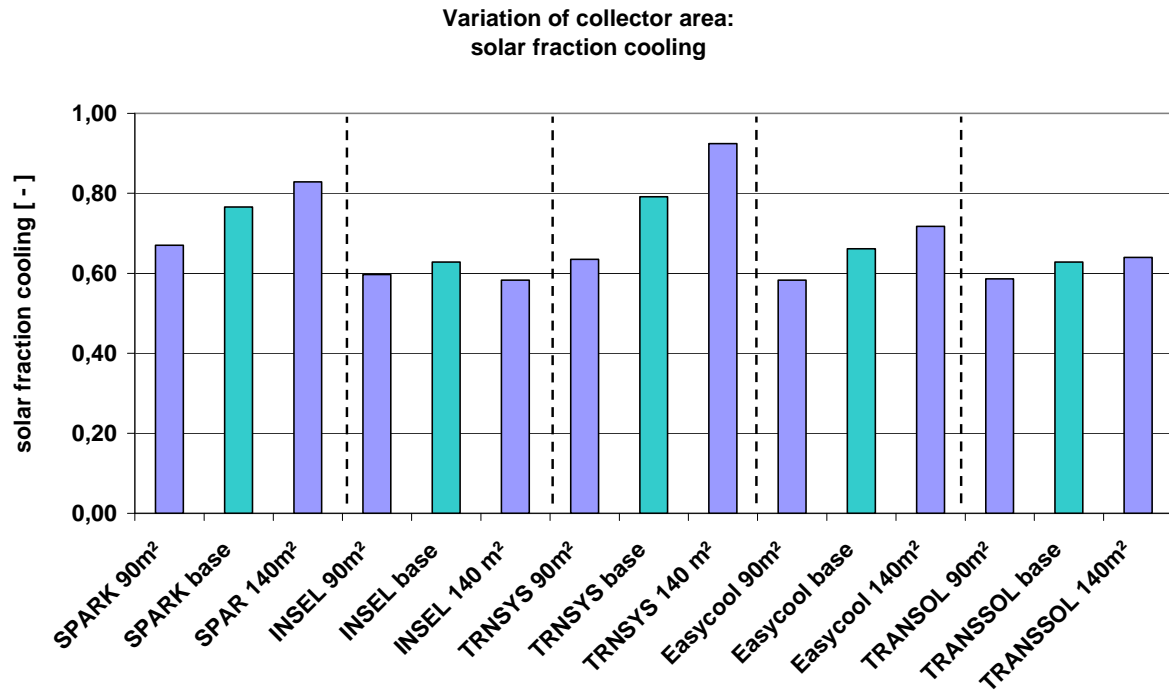

Figure 12: Solar fraction cooling/ variation of collector area

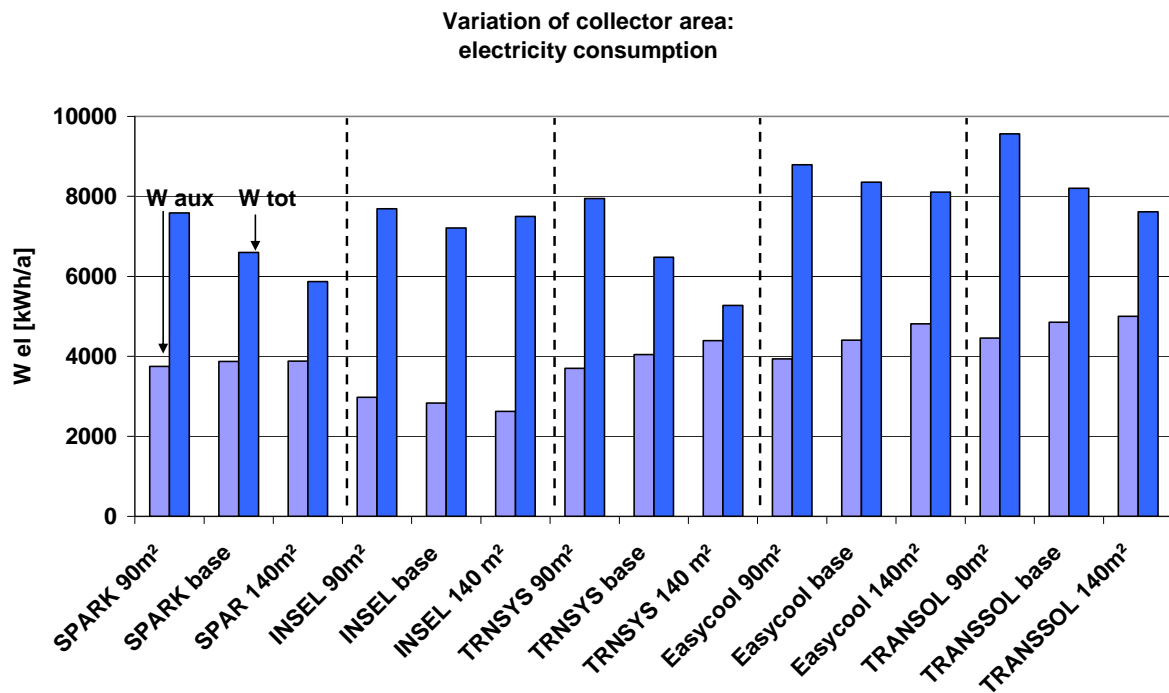

Figure 13: Electricity consumption/ variation of collector area

Variation of chiller starting temperature – simulation results

The results of the variation of the chiller starting temperature are shown in Figure 14 to Figure 16. In all simulations, the tendency of reaction to an increase in chiller starting temperature is the same. An increase of the chiller starting temperature leads to a decrease in the specific collector yield due to a smaller amount of useful solar heat. Hence, the solar

fraction decreases as well. Again, the INSEL simulation shows the most surprising behavior. With an increase in chiller starting temperature from 80°C to 85°C, the solar fraction falls significantly and seems to remain on a constantly low level. The decrease seems to follow a step function. In all other simulations, the decrease is almost linear.

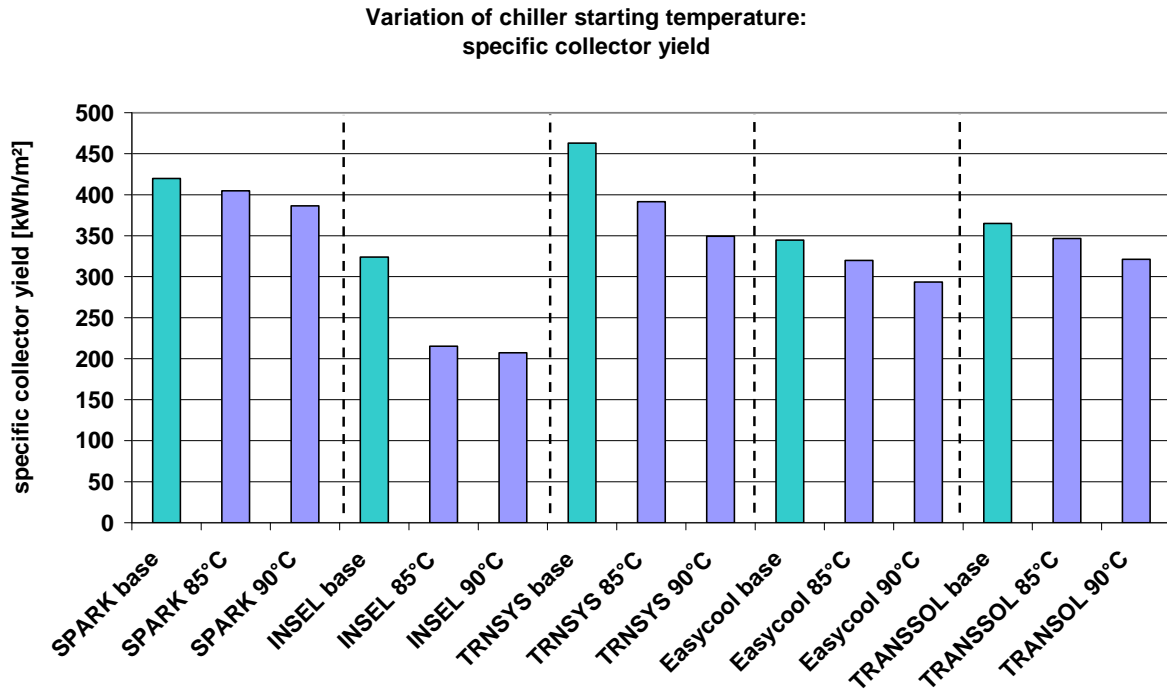

Figure 14: Specific collector yield / variation of chiller starting temperature

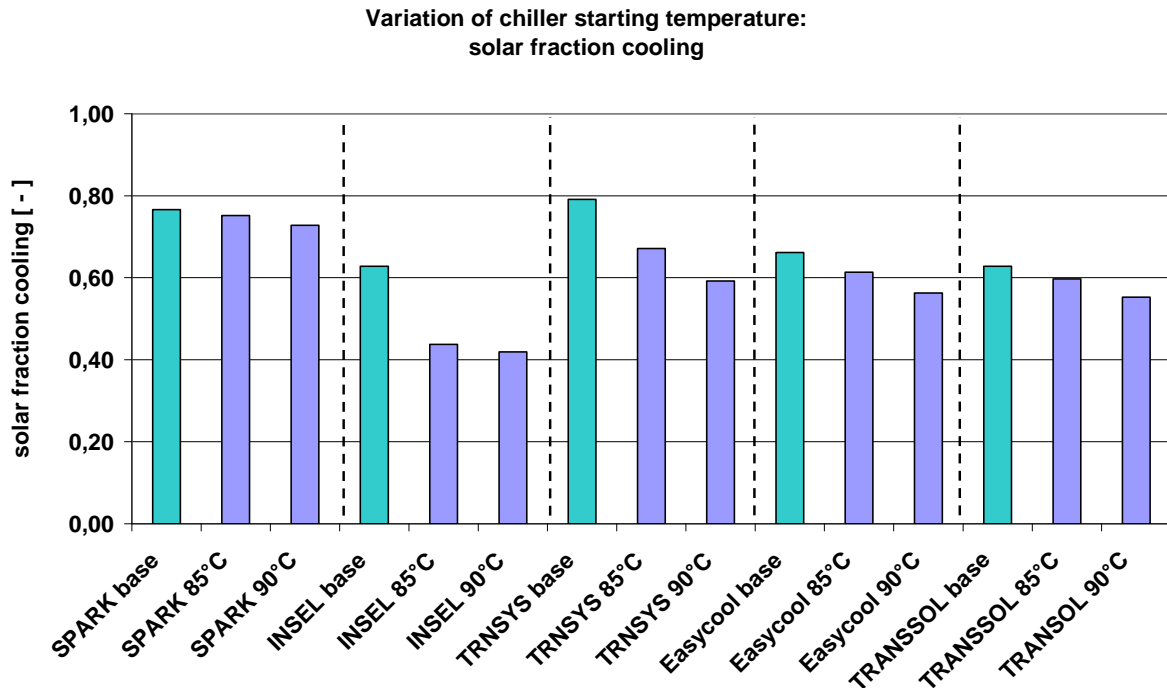

Figure 15: Solar fraction cooling/ variation of chiller starting temperature

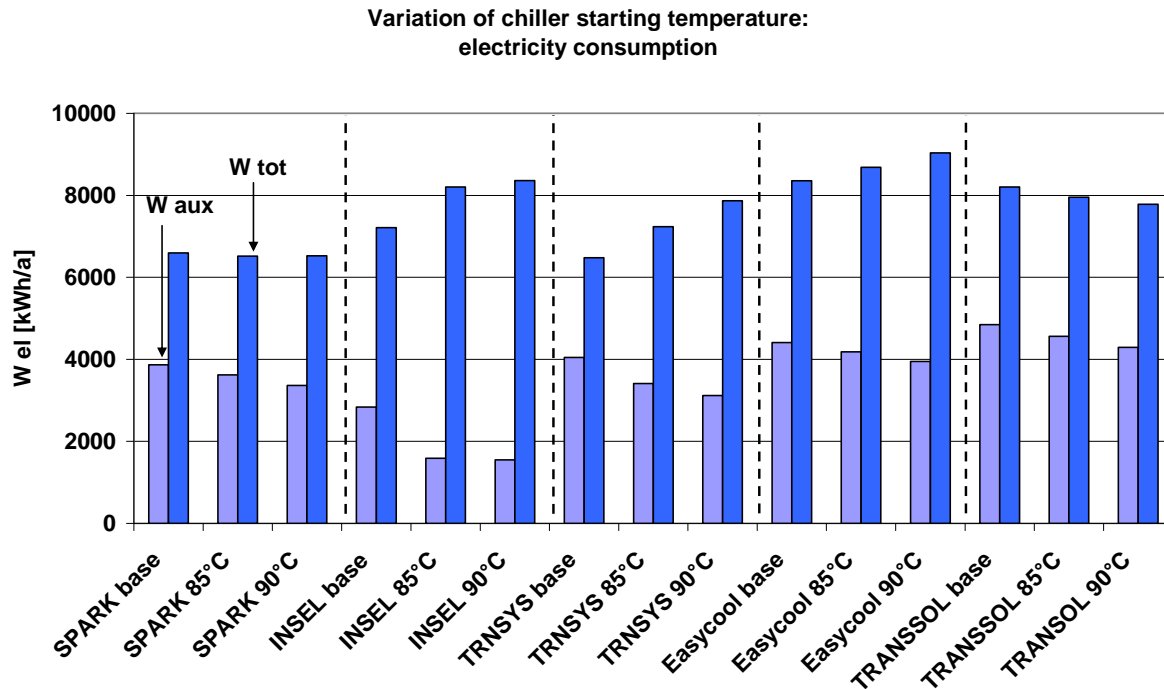

Figure 16: Electricity consumption/ variation of chiller starting temperature

Results interpretation – identification of differences between the simulations

From the presentation of the simulation results it is obvious that simulation results vary in a certain range. In order to understand the origin of these different results, the boundary conditions and assumptions of the different simulations were discussed by the contributing participants. Table 14 summarizes the differences in simulation settings. The main differences were found in the chiller model, the collector model and the assumed specifics of the control strategy.

The differences in the absorption chiller models reflect that an equivalent chiller model is simply not available for the different tools. The TRNSYS and INSEL simulations use the characteristic equation model [1] for the chiller but the parameter identification has not been done for the same Yazaki WFC10 chiller. The parameter identification of the TRNSYS model (type 177) has been done with measurement data of the old Yazaki chiller (with bubble pump). For INSEL, the parameter identification has been done with the manufacturer data of the new Yazaki chiller (with “normal” solution pump). In the INSEL model, the internal energy balances are solved for each time step as a function of the external entrance temperatures, so that changing mass flow rates can be considered in the model [2]. The performance data of the old chiller is not as good as the new one especially for high hot water temperature in the generator. This reflects in the higher average annual COP that is obtained in the INSEL simulations as compared to the TRNSYS simulations (baseline: 0.69 INSEL, 0.61 TRNSYS). TRANSOL uses a performance map model of the old Yazaki WFC10 chiller, reflecting manufacturer’s specifications. As mentioned before, the SPARK simulation uses a performance map of the 30 kW EAW chiller. EasyCool calculates chiller performance via a constant annual COP and is therefore the least detailed model.

Table 14: Identified differences in simulation setup of the particular contributions

	INSEL	TRNSYS	TRANS OL	SPARK	Easy- cool
General: time step	6 min	10 min	0.5 h	10 min	1 h
Solar: radiation interpolation	No	No	Yes	Yes	No
Solar: collector thermal mass included in model	Yes	No	Yes	No	No
Solar: stagnation taken in account	Yes	No	Yes	No	No
Chiller: characteristic temperature ($\Delta\Delta T$) model	Yes	Yes	No	No	No
Chiller: performance map model	No	No	Yes	Yes, 30 kW EAW	No
Chiller: constant COP model	No	No	No	No	Yes
Chiller: old model (WFC10 with bubble pump)	No	Yes	Yes	No	No
Chiller: new model (WFC10 with solution pump)	Yes	No	No	No	No
System: piping modeled	No	No	Yes	No	No
System: volume flow hot water to chiller	4.3 m ³ /h	4.3 m ³ /h	8.6 m ³ /h	4.3 m ³ /h	No
System: variable speed pumps only for P3 in heating mode and P6	Yes	No	No	No	No
Freezing protection in evaporator for the chiller mode	Yes	No	No	No	No

In the following, the main peculiarities of the simulations with the individual tools are commented.

TRNSYS

The TRNSYS results especially showed a high share in heat produced by the solar collectors. This reflects also in cold produced by the chillers and resulting high solar fractions. The collector was Type 1, which models the thermal performance of a flat-plate solar collector. In this instance of Type1, a second order quadratic function is used to compute the incidence angle modifier. The coefficients of the function are given in Table 7. Collector slope was assumed 38 deg (latitude of Palermo) facing true south. The most likely reasons for the high solar fractions in the TRNSYS results are

- Non-insulated piping, therefore less thermal loss
- No stagnation assumed
- No thermal mass of collector

TRANSOL

The collector model of TRANSOL is a new component which includes inertial and several modes of operation, from fix flow to match flow driven by set temperature or constant temperature difference; this new model allows bidirectional IAM correction for evaluating in the correct way CPC reflectors. The absorption machine is a standard component which reads performance data from an external file.

Baseline TRANSOL results are between the results of other simulation programs. Simulation results show how increasing generator driving temperature improves significantly COP but decreases collector efficiency. The result is a small decrease of cooling demand covered by the absorption machine.

Higher electricity consumption may be due to all parasitic consumptions of the whole thermal system: not only the primary, secondary, distribution, recirculation pumps, controller and valves but also electricity consumption from the absorption cooling machine or cooling tower are taken in account. Indeed W_{aux} is almost the same as EasyCool results. Total electricity consumption falls when increasing starting temperature due to pumps working less time than in smaller starting temperatures; it is more difficult to the system to achieve higher temperatures for the same meteorological and demand conditions.

INSEL

The collector model implemented in INSEL is based on the Bengt Perers model used for the TASK26 and 32 [3]. It takes into account the thermal capacity of the collector (including water) and also optical calculations according to the different collectors (IAM factor in one direction for flat plate collector and in 2 directions (transversal and longitudinal) for vacuum tubes collectors).

The main differences in simulation results originate from the more detailed control strategy implemented in the INSEL simulation. This includes taking account of collector stagnation and shutting down of the chiller when too much cold is produced (freezing protection). For an example day this is presented in the following (Figure 17).

The chiller starts running around 10h and stops two times around 11h because the temperature at the bottom of the cold storage is below 3°C. Then the chiller starts again but since the temperature in the hot storage is high (around 95-100°C) and the temperature at the top of the cold tank is relatively low (9-10°C), the chiller is put in standby because of a too low temperature inside the evaporator (freezing protection). The collector field is in stagnation because no more solar energy can be introduced into the hot tank. Then when the temperature in the cold tank gets higher, the chiller runs until the temperature at the top of the hot tank reaches 78°C.

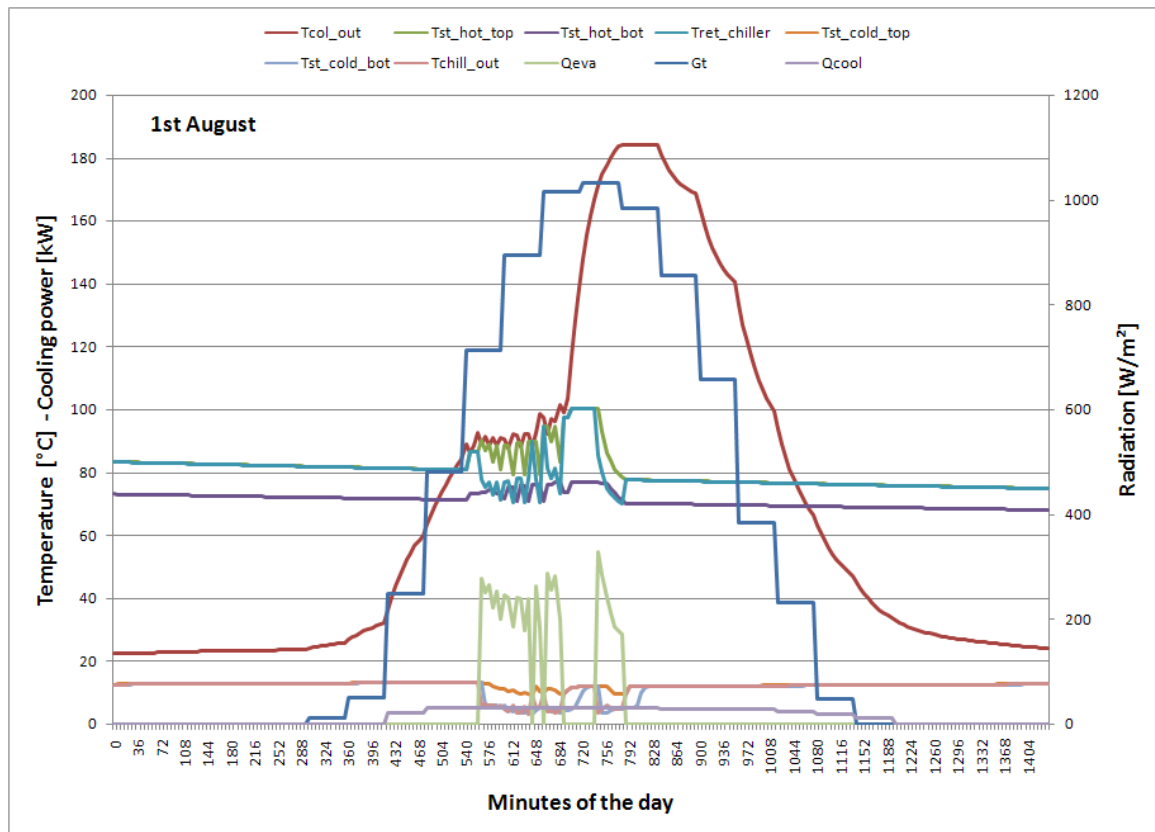

Figure 17: Simulation results of an exemplary day in INSEL

The different results in the variation simulations may also be explained by the example day:

- Starting temperature: if the starting temperature increases, the performance of the chiller increases, the cold storage is more quickly filled. Which means, the freezing protection inside the evaporator put the chiller in standby more often. No more solar heat can be used from the tank and then stagnation problems occur.

That is why the solar fraction decreases so quickly by increase the starting temperature of the chiller

- Collector area: for the same reason as before. When increasing the collector area, are also increased the problem of stagnation and also the problem of freezing protection (since the temperature in the tank is really high

SPARK

In SPARK simulations also high solar fractions could be observed in comparison to the other simulation tools. The main reason of the deviations of the SPARK simulation results probably originate from the solar collector model. The solar collector model is based on the efficiency method. The efficiency equation is given by the manufacturer and depends on the inlet and outlet temperature of the collector and climatic conditions (the outside temperature (T_{ambient}) and the sunshine (G)). Stagnation and thermal mass of collectors are not taken account in this model.

This kind of model slightly overstates solar collector field performances. Then the hot water tank temperature is a little bit high, so the inlet temperature of the generator is also high.

Indeed, the chiller (30 kW EAW) runs in very good conditions since the inlet temperature of the generator is high so the chilled water production is also slightly overstated. In the chiller model, the higher the inlet temperature of the generator is, the better the chiller performance. The absorption chiller model is based on operating curves of the chiller given by the manufacturer. Thanks to these curves and depending on the inlet temperature of the generator, it is possible to determine the refrigerated capacity of the chiller, the generator capacity and the cooling capacity (absorber + condenser).

A second reason of this deviation can come from the missing simulation of a heat exchanger between the primary and secondary solar loop.

EasyCool

EasyCool is a simple pre-design tool, based on solving energy balances on an hourly basis. The collector model is a simple efficiency model and does not include the collector thermal mass. Collector stagnation and freezing protection of the chiller are not included. A chiller starting temperature may be given, however it is not possible to define a hysteresis for chiller operation (first variation).

The EasyCool results lie well within the range of the other results. Due to the simple models, the constant COP assumption and the missing implementation of a control strategy, the results vary approximately linearly with a variation of collector area and chiller starting temperature for the simulated range.

It can be observed that EasyCool simulation seem to slightly overestimate power consumption. This mainly originates from the simulation of constant speed pumps. It is not possible to include variable speed pumps in the calculations. This is a known problem with EasyCool results.

3 Conclusions

A general interpretation of the results of the cross-validation of different tools is quite difficult. Interpretation of results revealed that a higher amount of fixed parameters might be necessary in future benchmarks in order to obtain a better understanding of the differences between the tools. The simulation comparison rather gives a range of possible simulation results which may be obtained by using available models in available tools – and simulations performed by different users and tools.

One difficulty in results interpretation is that the “real” system performance is not known. This was often discussed – however a validation with annual monitoring data could not be conducted as no monitoring data of a system configuration that could be simulated in all involved tools was available. This would be scope of future work. Therefore, it is also not possible to classify the different simulation and pre-design tools according to their predictive quality.

The cross-comparison of the results leads to the following main conclusions directly relating to the results of the chilled water system simulations:

- The calculation results obtained by the pre-design tools (SolAC and EasyCool) are similar due to similar calculation method (hourly energy balances)
- The reference system simulation leads to similar results in both the pre-design tool EasyCool as well as in TRNSYS. This is mainly attributed to low complexity of the simulation model (constant COP approach).
- For the detailed system simulation, the simulation of the solar system is crucial
- A more detailed system control including collector stagnation leads to significantly different results in comparison to simple control strategies
- Using collector models which take account of the collector thermal mass lead to a lower share of useful solar heat
- Although looking at the same absorption chiller (Yazaki WFC10) the chiller models implemented in the different tools are all different
- A margin of around 6% deviation of the simulation results of the thermal parameters from their mean seems is the best possible in the cross-comparison of the three closest baseline simulations – however the upper margin of around 20% observed for all simulations may be more close to the real margin of variation
- In terms of electricity consumption, differences in the range of +/- 10% should be assumed. When looking at saved electricity - and therefore primary energy saved - the relative variations become much higher. The uncertainty of prediction of primary energy savings via simulation is very high.

The simulation benchmark further allows learning on crucial points of simulation of solar assisted cooling systems in general. The main general conclusions that must drawn are as follows:

- An equal level comparison of the same system and control in different software packages is almost not possible. The level of detail and the assumptions, boundary conditions and individual models vary too much to allow a general comparison to be drawn. This holds especially for the tools that allow a maximum freedom to the users (TRNSYS,INSEL,Spark,...).
- It is important to understand the similarities and differences in the individual models for the simulation results presented.
- Trends can be seen in the comparison presented but have to be taken with a grain of salt. The reference case is not free from error either.
- The use and application of more complex software packages like TRNSYS/TRANSOL, INSEL and SPARK should only be undertaken by qualified and trained users. They need to understand the models and their assumptions.
- There is no “plug-and-simulate” software for solar cooling available yet - all packages require technical understanding of the system.
- The more a software has been used and cross-validated by multiple users the less likely the error will be on the components. This does not hold true for systems!

4 Bibliography

[1] Hellmann, H.-M., Schweigler, C., Ziegler, F.: The characteristic equation of sorption chillers. Proc. of the Int. Sorption Heat Pump Conf. (ISHPC 1999), Munich, 24.–26. March 1999; pp. 169–172

[2] Ursula Eicker, Dirk Pietruschka “Design and performance of solar powered absorption cooling systems in office buildings” Energy and Buildings (2009), Volume 41, Issue 1, January 2009, Pages 81-91

[3] Bengt Perers and Chris Bales, “A Solar collector model for TRNSYS simulation and system testing” IEA SHC Task 26, Solar combisystems, December 2002